

# HEAVY DUTY BASE MACHINE FOR FOUNDATION WORK

# KOBELCO

# BM700HD

Max. Lifting Capacity: 70 Metric Tons at 3.7 Meters / Max. Boom Length: 54.9 Meters

## Specifications

### Newly developed wet-type disc brake

- The new forced-circulation oil-cooled wet-type multi-disc brake gives dependable braking power throughout the toughest digging operations requiring repeated hoisting and free-falling.
- Oil circulation through the brake's discs holds down the brake temperature while long, continuous operations and maintains braking efficiency.
- The light pedal control reduces operator fatigue over extended work periods.

### Heavy-duty winch provides powerful line-pull

The maximum line-pull of 20 tons matches that of an 80-ton machine and can accommodate a 2,000mm casing jack. Makes easy to work on rigorous bucket digging and casing removal work in casing oscillator applications.

### Large capacity drums

The large-capacity, compactly fitting drums (617mm) hold 44m (22 parts of line) of 26mm wire rope on the first layer. Enables hammer-grab digging of 30m depth on the first layer, extending wire rope life span.

### Full size third drum (optional)

Internally installed brakes and a new machinery layout make room for a third drum with the same capacity as front and rear drums placed behind them, allowing the use of a greater range of attachments.

### Simplified maintenance

The new disc brake makes a great saving on the time and cost it took to change brake linings and adjust the previous drum brake. The engine has also been re-positioned at the side to ease checks and maintenance.



**KOBELCO CONSTRUCTION MACHINERY CO., LTD.**

# Specifications

## Upper machinery



**Power plant**  
**Model** ..... Mitsubishi 6D24-TE1  
**Type** ..... Water-cooled, direct fuel injection, with turbocharger

**No. of cylinder** ..... 6  
**Bore and stroke** ..... 130 mm x 150 mm  
**Displacement** ..... 11.945 liters  
**Rated power** ..... 184 kW (250 PS) at 2,000 rpm (JIS D1005)  
**Max. torque** ..... 103 N·m (105 kg·m) at 1,400 rpm (JIS D1005)

**Cooling system** ..... Liquid, recirculating bypass  
**Starter** ..... 24 V, 5.5 kW  
**Generator** ..... 24 V, 80 A  
**Cycles** ..... 4  
**Radiator** ..... Corrugated type core, thermostatically controlled

**Air cleaner** ..... Dry type with replaceable paper element  
**Fuel tank capacity** ..... 400 liters  
**Batteries** ..... Two 12V, 150 A-hr capacity batteries, series connected



### Hydraulic System

**Pumps:** All three variable displacement plunger pumps are driven by heavy-duty pump drive. One of these pumps is used in the right propel circuit and hook hoist circuit, and can accommodate an optional third circuit. Another is used in the left propel circuit, boom hoist circuit and hook hoist circuit. The third variable displacement pump is used in the swing circuit. In addition, two gear pumps are used in the control system and auxiliary equipment. One of these serves the clutch and brakes.

**Control:** Full-flow hydraulic control system for infinitely variable pressure to front and rear drums, boom hoist brakes and clutches. Controls respond instantly to the touch, delivering smooth function operation.

### Max. relief valve pressure:

**Load hoist, boom hoist and propel system** ..... 30.9 MPa (315 kg/cm<sup>2</sup>)  
**Swing system** ..... 27.5 MPa (280 kg/cm<sup>2</sup>)  
**Control system** ..... 7.8 MPa (80 kg/cm<sup>2</sup>)

**Reservoir capacity:** 450 liters

**Cooling:** Oil-to-air heat exchanger (plate-fin type)

**Filtration:** Full-flow and bypass type with replaceable paper element

**Electrical system:** All wiring corded for easy servicing, individual fused branch circuits.



### Load hoist system

Front and rear drums for load hoist powered by a hydraulic variable plunger motors, driven through planetary reducers.

**Brakes & Clutches (compatible):** Forced-circulation oil-cooled wet-type multi-disc brakes, each using positive and negative actuation.

The drums are manually locked by the control cable.

Both positive and negative brake systems are available in lever neutral position.

**Drums:** (front and rear): 614 mm P.C.D. x 617 mm wide drums, each grooved for 26 mm wire rope.

Rope capacity of 170 m working length and 300 m storage length.

**Line speed:** Single line on the first drum layer

**Hoisting** ..... 100/60 m/min  
**Lowering** ..... 100/60 m/min

**Optional third drum:** with the same dimensions as front and rear drums.

**Line speed:** Single line on the first drum layer

**Hoisting/lowering** ..... 50 m/min

**Optional hydraulic outlet:** provided for auger drive, diaphragm wall bucket and other attachments.

No. of outlet	Max. oil flow	Max. pressure
A*	460 liters/min	315 kg/cm <sup>2</sup>
B	200 liters/min	315 kg/cm <sup>2</sup>
C	73 liters/min	210 kg/cm <sup>2</sup>

\*A shows values when two pumps combined.



### Boom hoisting system

Powered by a hydraulic axial piston motor through a planetary reducer.

**Brake:** A spring-set, hydraulically released multiple-disc brake is mounted on the boom hoist motor and operated through a counter-balance valve.

**Drum:** Single drum, grooved for 16 mm dia. wire rope.

**Line speed:** Single line on first drum layer

**Hoisting** ..... 65 m/min

**Lowering** ..... 65 m/min



### Swing system

**Swing unit:** Powered by hydraulic plunger motor driving spur gears through planetary reducers, the swing system provides 360° rotation.

**Swing speed** ..... 3.5 rpm

**Swing brakes:** A spring-set, hydraulically released multiple-disc brake is mounted on swing motor.

**Swing circle:** Single-row ball bearing with an integral internally cut swing gear.

## Lower machinery



**Carbody:** Steel-welded carbody with axles.

**Crawler:** Crawler assemblies can be hydraulically extended for wide track operation or retracted for transportation. Crawler belt tension is maintained by hydraulic jack force on the track-adjusting bearing block.

**Crawler drive:** Independent hydraulic propel drive is built into each side frame, each with a hydraulic motor propelling a driving tumbler through a planetary gear box.

**Crawler brakes:** Spring-set, hydraulically released multiple-disc parking brakes are built into each propel drive.

**Steering mechanism:** A hydraulic propel system provides both skid steering (driving one track only) and counter-rotating steering (driving tracks in opposite directions).

**Track rollers:** 10 lower rollers and 2 upper rollers are fitted to each side frame, sealed and maintenance-free.

**Shoes (flat):**

**Number** ..... 62 each side

**Standard flat shoe width** ..... 800 mm

**Max. travel speed:**

**High range** ..... 1.7 km/h

**Low range** ..... 1.1 km/h

**Max. gradeability:** 40%



### Weight

**Operating weight:**

Approx. 69,000 kg (including 12.2 m (40 ft) boom and 70-ton hook block)

**Ground pressure:** Average 77 kPa (0.80 kg/cm<sup>2</sup>) with 800 mm shoes

## Standard Equipment

<b>Upper structure/Lower structure</b>
Counterweight (three pieces): 22.9 ton (total weight)
800mm-shoe crawlers
150AH battery
Gantry raising/lowering cylinder
Electric hand throttle grip
Variable boom hoist speed controller
Variable main/aux. hoist speed controller
Side deck (for cab)
Step (equipped on left-side guard)
Two front working lights
<b>Cab &amp; Control</b>
Totally enclosed, full vision cab with safety glass
Removable upper front window
Fully adjustable, high backed seat with a head-rest and armrests
Intermittent wiper and window washer (roof, front and lower front window)
Foot pedals for front and rear drum
Four short hand levers for front and rear drum, swing and boom drum controls
<b>Safety Device</b>
Boom back stop
Check & Safety Monitor (shows gauges and warning signs)
Over-hoist prevention device
Release prevention key for hook over-hoist prevention device
Boom over-hoist auto-stop device
Hook over-hoist auto-stop device
Function lever lock switch (main, aux. and boom hoist)
Propel lever lock
Cable-type drum safety pawl (main, aux. and boom hoist)
Negative brake in lever neutral-position (main, aux., boom hoist and propel)
Brake fail-safe function (main, aux., boom hoist and propel)
Service brake pedal lock (main and aux. hoist)
Neutral brake release prevention key (main and aux. hoist)
Automatic brake system in engine-stop
Hydraulically safety valve (main, aux., boom hoist and propel)
Signal horn
Swing lock pin (two position pin-hole lock)
Swing flashers
Swing warning buzzer

## Optional Equipment

<b>Upper structure/Lower structure</b>
Load moment limiter
Third drum with free-fall function (wire rope: 26mm dia. x 145 m)
Self-removing counterweight system
Hydraulic power outlet for diaphragm wall bucket and others
7-spool valve
Hydraulic tag line
Boom hoisting pedal (right pedal)
Foot acceleration function (right pedal only or both pedals)
Hook height/depth level indicator
Level indicator
Travel kit
Rear view camera (color)
Camera for the monitoring of the main and aux. drums (color)
Exterior indication light for over load condition: 3-colors (round type or rectangular type)
Yellow rotating light
Obstacle light
Anemometer
Electric fuel pump
One way call
170 AH battery for cold district areas
Vandalism guard for cab roof
Vandalism guard for upper front window
Louver door
Cat walks for each sides of upper machine
Hand rail equipped on top of upper machine
Ladder for right guard
Tool box
Fire extinguisher
Electric fan

## Other amenities

<b>Upper structure/Lower structure</b>
Slip-proof pad (mounted on the guard), Tools (for routine maintenance), Two back mirrors, Mirror for monitoring drums
<b>Cab</b>
Air conditioner, Convenient compartment (for luggage), Cup holder, AM Radio, Ashtray, Cigarette lighter, Sun visor, Roof blind, Cloth floor mat, Rubber cover for brake pedal, Shoe tray

# Crane attachment



## Boom:

Welded lattice construction using tubular, high-tensile steel chords with pin connections between sections.

Max. lifting capacity	70,000 kg
Basic boom length	12.2 m (40')
Max. boom length	54.9 m (180')



## Jib (optional):

Welded lattice construction using tubular, high-tensile steel chords with pin connections between sections.

	Fixed jib
Max. lifting capacity	6,600 kg
Max. jib length	18.3 m (60')
Max. total length (Boom length + jib length)	42.7m (140') + 18.3 (60') 45.7m (150') + 12.2 (40')



## Hook blocks

A range of hook blocks can be specified, each with a safety latch.

Lifting capacity	70tons	50tons	32tons	11tons ball hook
No. of sheaves	3	3	1	0
Weight (kg)	850	700	550	300

## Diameter of wire ropes

### Standard:

Hook hoist	26 mm
Boom hoist (12-part line)	16 mm
Boom guy line (2 lines)	30 mm

### Optional:

Jib hook hoist	26 mm
Jib back stay guy line (2 lines)	20 mm

**Boom hoist reeving:** 12 parts of 16 mm dia. wire rope

**Boom backstops:** recommended for all boom lengths

## Line pull

(for crane, diaphragm wall bucket, etc.)

	Max. permissible	Max. available
Front	108 kN (11,000 kg)	196 kN (20,000 kg)
Rear	108 kN (11,000 kg)	196 kN (20,000 kg)

## Standard Attachment & Accessories

7.0 m (23') upper boom
5.2 m (17') lower boom
70-ton hook (3-sheave)
Wire rope for main hoist: 26 mm dia. x 170 m
Wire rope for boom hoist: 16 mm dia. x 135 m
Upper spreader automatic storage device

## Optional Attachment & Accessories

3.0 m (10') insert boom
6.1 m (20') insert boom
9.1 m (30') insert boom
3.05 m (10') upper jib
3.05 m (10') lower jib
3.05 m (10') insert jib
6.1 m (20') insert jib
50-ton hook (3-sheave)
32-ton hook (1-sheave)
11-ton ball hook
11-ton light weight ball hook
Auxiliary sheave (point sheave: one or two)
Wire rope for auxiliary hoist (26 mm dia. x 125 m)
Foot step for boom
Hand rail for boom (removable type)
Protect net for upper boom
Guy lines for lifting magnet and clamshell

## Main Boom Working Ranges

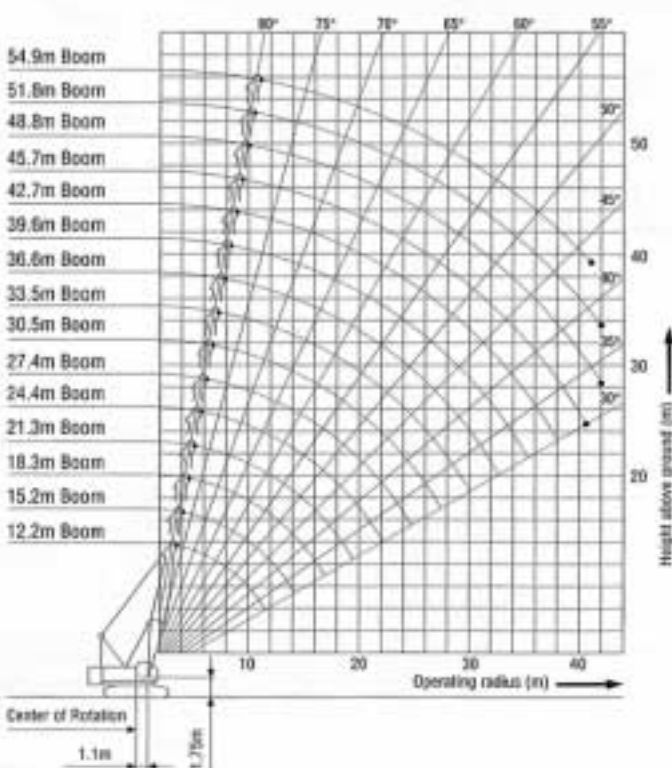



### Notes:

- Operating radius is the horizontal distance from the center of rotation to the center of gravity of the load.
- Rated loads included in the charts are the maximum allowable freely suspended loads at a given boom length and jib length, boom and jib angle, and radius, and have been determined for the machine standing level on firm supporting surface under ideal operating conditions. The user must limit or de-rate loads to allow for adverse conditions (such as soft or uneven ground, out-of-level conditions, winds, side loads, pendulum action, jerking or sudden stopping of loads, inexperience of personnel, multiple machine lifts, and traveling with a load).
- Capacities do not exceed 78% of minimum tipping loads. Capacities based on factors other than machine stability such as structural competence are indicated by black line. Attempt to over load could damage the boom, jib and frame, etc. without tipping.
- The rated loads are determined in accordance with Japanese Regulation.
- Areas on rated charts where no rating are shown, operation is not intended or approved.
- Actual allowable loads of boom must not exceed either the maximum load at the each number of reeving mentioned in the following article 8, or the rated loads for the boom length. Actual hoistable loads using the boom are determined by deducting the weight of the load-handling gear (such as hook block, slings and cables) from the ratings and should not exceed the ratings for the hook block.
- For configurations of insert booms and guy line assembly, instructions in the operator's manual must be strictly observed.

### 8. Max. hoisting load by number of reeving

No. of parts of line	1	2	3	4	5	6	7
Max. load (metric ton)	11	22	33	44	55	66	70

- An auxiliary sheave can be fitted to boom of 12.2 m to 51.8 m.
- Rated loads for auxiliary sheave are determined by deducting the ball-hook (300 kg) and load handling gear (sling and cables) from individual ratings provided each main hook in use, but must not exceed a maximum 11.0 ton.
- The maximum operating radius of an auxiliary sheave must not exceed the maximum operating radius of the boom. The minimum operating radius of the auxiliary sheave is determined by the equivalent angles of boom at the minimum radius.
- Actual allowable loads of the boom when an auxiliary sheave is attached are determined by deducting the weight of the auxiliary sheave, main hook, ball-hook (300kg) and the load handling gear (such as slings and cables) from the ratings.
- Do not operate the main hook and auxiliary sheave hook simultaneously.
- Refer to the operator's manual for appropriate type of hook block and number of reeving at each boom length.
- Always have the gantry fully raised and use the backstop during operations.
- Boom hoist reeving must be twelve parts of line.
- In principle, the boom should be erected over the front of the crawlers.
- Both crawlers should be fully extended.
- Figures shown by (ft) in the boom configuration are for reference only.

### Fixed Jib Working Range (Offset angle: 10°)

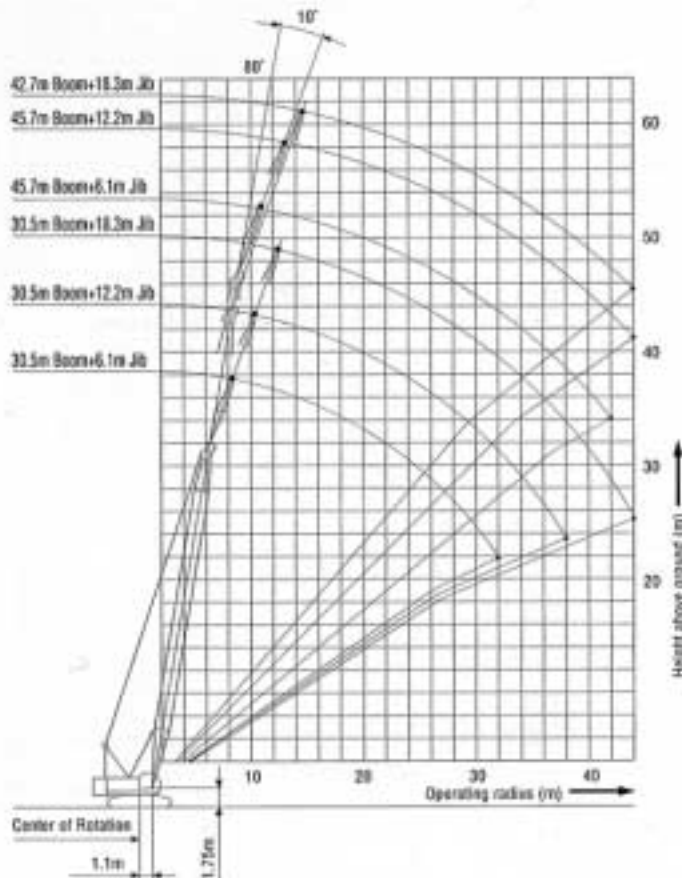

### Fixed Jib Working Range (Offset angle: 30°)

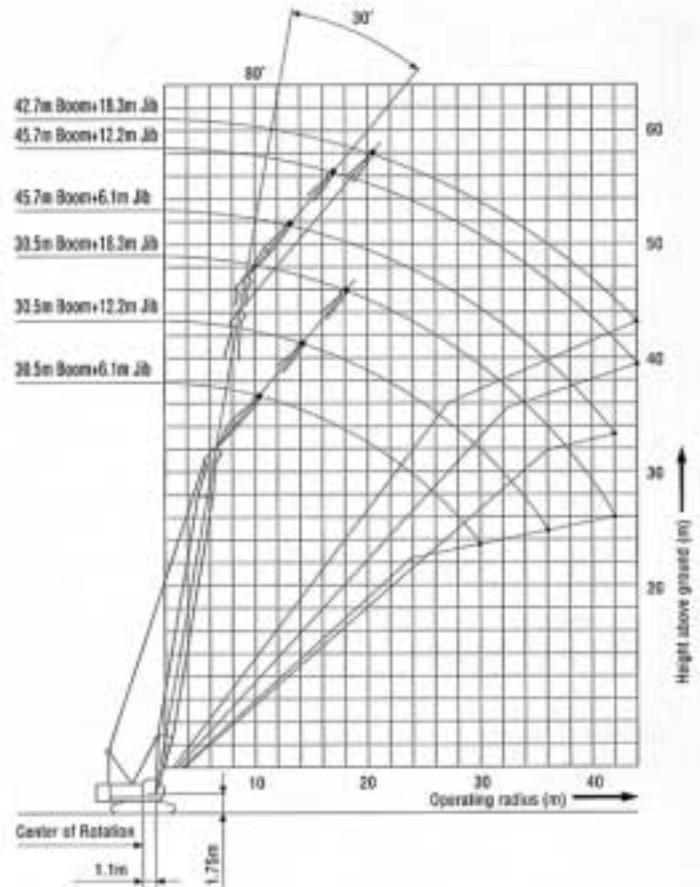

# Boom Lifting Capacities

Unit: metric ton

## Rated loads in metric tons for 360° working area

Crawler fully extended

Working radius m	Boom length m (ft)																Working radius m
	12.2 (40)	15.2 (50)	18.3 (60)	21.3 (70)	24.4 (80)	27.4 (90)	30.5 (100)	33.5 (110)	36.6 (120)	39.6 (130)	42.7 (140)	45.7 (150)	48.8 (160)	51.8 (170)	54.9 (180)		
3.7	70.0/3.7																3.7
4.0	68.0																4.0
4.2	65.0	64.2/4.3	57.2/4.8														4.2
5.0	53.2	53.1	53.0	50.3/5.3	43.4/5.9												5.0
6.0	41.3	41.2	41.1	41.1	41.0	38.0/6.4	33.5/6.9										6.0
7.0	32.6	32.5	32.4	32.4	32.3	32.2	32.1	30.3/7.5									7.0
8.0	26.9	26.8	26.7	26.7	26.6	26.5	26.4	26.3	26.1/8.0	24.3/8.5							8.0
9.0	22.8	22.7	22.6	22.6	22.5	22.4	22.3	22.2	22.1	22.0	20.8/9.0	19.9/9.6					9.0
10.0	19.7	19.6	19.5	19.5	19.4	19.3	19.2	19.1	19.0	18.9	18.8	18.7	17.7/10.1	16.3/10.6	13.2/11.2		10.0
12.0	15.9/11.8	15.7	15.6	15.5	15.4	15.3	15.2	15.1	15.0	14.9	14.9	14.7	14.6	13.5	13.2		12.0
14.0		12.9	12.8	12.6	12.5	12.4	12.3	12.2	12.1	12.0	12.0	11.8	11.7	11.6	11.1		14.0
16.0		12.5/14.5	10.7	10.6	10.5	10.3	10.2	10.1	10.0	9.9	9.9	9.7	9.6	9.5	9.4		16.0
18.0			9.7/17.1	9.0	8.9	8.8	8.7	8.6	8.5	8.3	8.3	8.2	8.1	7.9	7.8		18.0
20.0				7.9/19.8	7.7	7.6	7.5	7.4	7.3	7.1	7.1	7.0	6.8	6.7	6.6		20.0
22.0					6.8	6.7	6.5	6.4	6.3	6.2	6.1	6.0	5.8	5.7	5.6		22.0
24.0					6.6/22.4	5.9	5.8	5.6	5.5	5.4	5.3	5.2	5.0	4.9	4.8		24.0
26.0						5.5/25.0	5.1	5.0	4.9	4.7	4.7	4.5	4.4	4.3	4.2		26.0
28.0							4.6/27.7	4.5	4.3	4.2	4.1	4.0	3.8	3.7	3.6		28.0
30.0								4.0	3.9	3.7	3.7	3.5	3.3	3.2	3.1		30.0
32.0								3.9/30.3	3.5	3.3	3.2	3.1	2.9	2.8	2.6		32.0
34.0									3.2/33.0	3.0	2.9	2.7	2.5	2.4	2.2		34.0
36.0										2.7/35.6	2.6	2.4	2.2	2.0	1.8		36.0
38.0											2.2	2.0	1.9	1.7	1.5		38.0
40.0											2.2/38.2	1.8	1.6	1.4	1.2		40.0
42.0												1.6/40.9	1.3/42.0	1.1/42.0	1.1/41.0		42.0

Note: rating inside shown in [ ] are determined by the strength of the boom or other structural components.

## Boom Arrangement

Boom length m(ft)	Arrangement A: 3.0m+6.1m+9.1m insert boom	Arrangement B: 3.0m+6.1m insert boom
12.2 (40)	※ Base Tip	
15.2 (50)	※ Base A Tip	
18.3 (60)	Base B Tip ※ Base A A Tip	
21.3 (70)	※ Base A B Tip Base C Tip	※ Base A B Tip
24.4 (80)	Base B B Tip Base A C Tip ※ Base A A B Tip	Base B B Tip ※ Base A A B Tip
27.4 (90)	※ Base A B B Tip Base B C Tip Base A A C Tip	※ Base A B B Tip
30.5 (100)	※ Base A B' C Tip Base C' C Tip	Base B B B' Tip ※ Base A A B B' Tip
33.5 (110)	Base B B' C Tip Base A C' C Tip ※ Base A A B' C Tip	※ Base A B B' B Tip

Base=5.2m (17'), Tip=7.0 (23')  
 Inserts: A=3.0m (10')  
 B=6.1m (20'), B'=6.1m (20') with lug  
 C=9.1m (30'), C'=9.1m (30') with lug

# Auxiliary Sheave Lifting Capacities

**BM700HD**

Unit: metric ton

## Rated loads in metric tons for 360° working area (without main hook)

Crawler fully extended

Boom length m (ft) Working radius m	12.2 (40)	15.2 (50)	18.3 (60)	21.3 (70)	24.4 (80)	27.4 (90)	30.5 (100)	33.5 (110)	36.6 (120)	39.6 (130)	42.7 (140)	45.7 (150)	48.8 (160)	51.8 (170)	Boom length m (ft) Working radius m
4.0	11.042	11.047													4.0
5.0	11.0	11.0	11.052	11.057											5.0
6.0	11.0	11.0	11.0	11.0	11.063	11.068									6.0
7.0	11.0	11.0	11.0	11.0	11.0	11.0	11.073	11.078							7.0
8.0	11.0	11.0	11.0	11.0	11.0	11.0	11.0	11.0	11.084	11.089					8.0
9.0	11.0	11.0	11.0	11.0	11.0	11.0	11.0	11.0	11.0	11.0	11.094				9.0
10.0	11.0	11.0	11.0	11.0	11.0	11.0	11.0	11.0	11.0	11.0	11.0	11.010.0	11.010.5	11.011.0	10.0
12.0	11.0	11.0	11.0	11.0	11.0	11.0	11.0	11.0	11.0	11.0	11.0	11.0	11.0	11.0	12.0
14.0	11.0/12.7	11.0	11.0	11.0	11.0	11.0	11.0	11.0	11.0	11.0	11.0	11.0	11.0	11.0	14.0
16.0		11.0/15.3	10.6	10.4	10.3	10.2	10.1	10.0	9.9	9.8	9.7	9.6	9.5	9.3	16.0
18.0			9.0/18.0	8.9	8.8	8.7	8.6	8.5	8.4	8.2	8.1	8.0	7.9	7.8	18.0
20.0				7.7	7.6	7.5	7.4	7.2	7.1	7.0	6.9	6.8	6.7	6.5	20.0
22.0				7.4/20.6	6.6	6.5	6.4	6.3	6.2	6.0	5.9	5.8	5.7	5.6	22.0
24.0					6.1/23.2	5.7	5.6	5.5	5.4	5.2	5.1	5.0	4.9	4.8	24.0
26.0						5.1/25.9	5.0	4.8	4.7	4.6	4.5	4.4	4.2	4.1	26.0
28.0							4.4	4.3	4.2	4.0	3.9	3.8	3.7	3.6	28.0
30.0							4.2/28.5	3.8	3.7	3.6	3.5	3.3	3.2	3.0	30.0
32.0								3.5/31.2	3.3	3.1	3.0	2.9	2.7	2.5	32.0
34.0									3.0/33.8	2.8	2.6	2.5	2.3	2.1	34.0
36.0										2.4	2.3	2.1	1.9	1.8	36.0
38.0										2.4/36.4	2.0	1.8	1.6	1.4	38.0
40.0											1.6/39.1	1.5	1.3	1.1/40.0	40.0
42.0												1.2/41.7	1.1/42.0		42.0

## Boom Arrangement

Boom length m(ft)	Arrangement A: 3.0m+6.1m+9.1m insert boom	Arrangement B: 3.0m+6.1m insert boom
36.6 (120)		
39.6 (130)		
42.7 (140)		
45.7 (150)		
48.8 (160)		
51.8 (170)		
54.9 (180)		

### Notes:

- The following cases require a single insert boom with lug of either 6.1 m (20') or 9.1 m (30').
  - When a jib is attached.
  - When assembling booms longer than 39.6 m (130') without using a support crane.
- Arrows indicate points where guy lines should be attached when using a jib together with arrangement of boom and insert boom with lug.
- ‡ indicates recommended arrangements.
- Guy lines should be 30 mm dia.

# Fixed Jib Lifting Capacities

Unit: metric ton

## Jib Rated loads in metric tons for 360° working area (Jib offset angle 10°/without main hook)

Crawler fully extended

Boom Length m (ft)	30.5 (100)			33.5 (110)			36.6 (120)			39.6 (130)			42.7 (140)			45.7 (150)	
Jib length m (ft) Working radius m	6.1 (20)	12.2 (40)	18.3 (60)	6.1 (20)	12.2 (40)	18.3 (60)	6.1 (20)	12.2 (40)	18.3 (60)	6.1 (20)	12.2 (40)	18.3 (60)	6.1 (20)	12.2 (40)	18.3 (60)	6.1 (20)	12.2 (40)
9	6.6/9.0																
10	6.6			6.6/10.0			6.6/10.0										
12	6.6			6.6			6.6			6.6/12.0			6.6/12.0			6.6/12.0	
14	6.6	6.6/14.0		6.6	6.6/14.0		6.6	6.6/14.0		6.6	6.6/14.0		6.6			6.6	
16	6.6	6.6	4.5/16.0	6.6	6.6	4.5/16.0	6.6	6.6	4.5/16.0	6.6	6.6	4.5/16.0	6.6	6.6/16.0		6.6	6.6/16.0
18	6.6	6.6	4.5	6.6	6.6	4.5	6.6	6.6	4.5	6.6	6.6	4.5	6.6	6.6	4.5/18.0	6.6	6.6
20	6.6	6.6	4.5	6.6	6.6	4.5	6.6	6.6	4.5	6.6	6.6	4.5	6.6	6.6	4.5	6.5	6.6
22	6.1	6.4	4.5	6.0	6.2	4.5	5.9	6.2	4.5	5.8	6.0	4.5	5.7	6.0	4.5	5.6	5.8
24	5.4	5.6	4.5	5.2	5.5	4.5	5.1	5.4	4.5	5.0	5.3	4.5	4.9	5.2	4.5	4.8	5.1
26	4.7	5.0	4.5	4.6	4.8	4.5	4.5	4.8	4.5	4.4	4.6	4.5	4.3	4.5	4.5	4.2	4.4
28	4.2	4.4	4.5	4.1	4.3	4.4	4.0	4.2	4.3	3.9	4.1	4.2	3.8	4.0	4.1	3.6	3.9
30	3.8	4.0	4.1	3.6	3.8	3.9	3.5	3.7	3.9	3.4	3.6	3.7	3.3	3.5	3.6	3.2	3.4
32	3.4/32.0	3.6	3.7	3.2	3.4	3.5	3.1	3.3	3.5	3.0	3.2	3.3	2.9	3.1	3.2	2.7	3.0
34		3.2	3.3	2.9	3.1	3.2	2.8	3.0	3.1	2.6	2.9	3.0	2.5	2.8	2.9	2.3	2.6
36		2.9	3.0	2.6/36.0	2.8	2.9	2.5	2.7	2.8	2.3	2.5	2.7	2.2	2.4	2.6	2.0	2.2
38		2.6/38.0	2.8		2.5	2.6	2.2/38.0	2.4	2.5	2.0	2.2	2.4	1.8	2.1	2.2	1.6	1.9
40			2.5		2.3	2.4		2.1	2.3	1.7/40.0	1.9	2.1	1.6	1.8	2.0	1.4	1.6
42			2.3		2.0/42.0	2.1		1.9	2.0		1.7	1.8	1.3	1.6	1.7	1.1/42.0	1.4
44			2.1/44.0			1.9/44.0		1.8/44.0	1.8/44.0		1.6/44.0	1.6/44.0	1.1/44.0	1.3/44.0	1.5/44.0		1.1/44.0

## Jib Rated loads in metric tons for 360° working area (Jib offset angle 30°/without main hook)

Crawler fully extended

Boom Length m (ft)	30.5 (100)			33.5 (110)			36.6 (120)			39.6 (130)			42.7 (140)			45.7 (150)	
Jib length m (ft) Working radius m	6.1 (20)	12.2 (40)	18.3 (60)	6.1 (20)	12.2 (40)	18.3 (60)	6.1 (20)	12.2 (40)	18.3 (60)	6.1 (20)	12.2 (40)	18.3 (60)	6.1 (20)	12.2 (40)	18.3 (60)	6.1 (20)	12.2 (40)
12	6.6/12.0			6.6/12.0			6.6/12.0										
14	6.6			6.6			6.6			6.6/14.0			6.6/14.0			6.6/14.0	
16	6.6	5.0/16.0		6.6			6.6			6.6			6.6			6.6	
18	6.6	5.0		6.6	5.0/18.0		6.6	5.0/18.0		6.6	5.0/18.0		6.6	5.0/18.0		6.6	
20	6.6	5.0	3.2/20.0	6.6	5.0		6.6	5.0		6.6	5.0		6.6	5.0		6.6	5.0/20.0
22	6.2	5.0	3.2	6.1	5.0	3.2/22.0	6.1	5.0	3.2/22.0	5.9	5.0	3.2/22.0	5.9	5.0	3.2/22.0	5.8	5.0
24	5.5	5.0	3.2	5.4	5.0	3.2	5.3	5.0	3.2	5.2	5.0	3.2	5.1	5.0	3.2	5.0	5.0
26	4.8	4.9	3.2	4.7	5.0	3.2	4.6	5.0	3.2	4.5	4.9	3.2	4.4	4.8	3.2	4.3	4.7
28	4.3	4.6	3.2	4.2	4.5	3.2	4.1	4.4	3.2	4.0	4.3	3.2	3.9	4.3	3.2	3.8	4.2
30	3.8/30.0	4.1	3.1	3.7	4.0	3.2	3.6	3.9	3.2	3.5	3.8	3.2	3.4	3.8	3.2	3.3	3.7
32		3.7	3.0	3.3/32.0	3.6	3.0	3.2	3.5	3.1	3.1	3.4	3.2	3.0	3.3	3.2	2.9	3.2
34		3.3	2.8		3.2	2.9	2.9/34.0	3.1	3.0	2.7	3.0	3.1	2.6	3.0	3.2	2.4	2.9
36		3.0/36.0	2.7		2.9	2.8		2.8	2.9	2.3	2.7	2.9	2.2	2.6	2.8	2.1	2.5
38			2.6		2.6/38.0	2.7		2.5	2.7	2.0/38.0	2.4	2.6	1.9	2.3	2.5	1.7	2.1
40			2.5			2.5		2.2/40.0	2.5		2.1	2.3	1.6/40.0	2.0	2.3	1.4	1.8
42			2.4/42.0			2.3			2.2		1.8	2.1		1.7	2.0	1.2/42.0	1.5
44						2.1/44.0			2.0/44.0		1.5/44.0	1.6/44.0		1.4/44.0	1.7/44.0		1.3/44.0

## Jib Component Chart

Boom Length m (ft)	Boom arrangement
6.1 (20)	Base ————— Tip
12.2 (40)	Base ————— A ————— Tip
18.3 (60)	Base ————— A ————— A ————— Tip

Base = 3.05 m (10'), Tip = 3.05 m (10'), Inserts: A = 6.1 m (20')

## Boom and Jib Combinations and Allowable Boom Angle

Boom Length	6.1 m jib		12.2 m jib		18.3 m jib	
	Offset angle	Offset angle	Offset angle	Offset angle	Offset angle	Offset angle
	10°	30°	10°	30°	10°	30°
30.5 m	36° - 80°	43° - 79°	36° - 78°	44° - 80°	35° - 78°	44° - 80°
33.5 m	32° - 80°	44° - 80°	32° - 79°	44° - 78°	40° - 79°	44° - 78°
36.6 m	34° - 80°	44° - 80°	34° - 79°	44° - 79°	44° - 79°	48° - 79°
39.6 m	35° - 79°	40° - 78°	39° - 80°	41° - 80°	47° - 80°	52° - 80°
42.7 m	32° - 79°	41° - 79°	43° - 78°	45° - 80°	50° - 79°	54° - 80°
45.7 m	41° - 80°	42° - 80°	46° - 79°	49° - 79°	-	-

### Note:

- Jib can be fitted to main boom between 30.5 m (100') and 45.7 m (150') in length.
- Fitting a jib requires an insert boom with lugs, 6.1m (20') or 9.1 m (30').
- Actual hoistable loads using the jib are determined by deducting the weight of the load-handling gear (such as hook block, slings and cables) from the individual ratings.
- 9.1 m (30') and 15.2 m (50') jib configurations are also available with 3.0 m (10') jib insert.



## Clamshell ratings in metric tons for 360° working area (Crawler fully extended)

For digging, or materials handling where horizontal pulling load is exerted on boom

Unit: metric ton

Working radius m	Boom length m (ft)	12.2 (40)	15.2 (50)	18.3 (60)	21.3 (70)	24.4 (80)
5.0		7.5				
6.0		7.5	7.5			
7.0		7.5	7.5	7.5		
8.0		7.5	7.5	7.5	7.5	
9.0		7.5	7.5	7.5	7.5	7.4
10.0		7.5	7.5	7.5	7.5	7.1
12.0		7.5	7.5	7.5	7.2	6.8
14.0			7.5	7.5	7.0	6.5
16.0				7.5	6.8	6.2
18.0					6.5	5.9
20.0					6.2	5.6
22.0						5.3

For materials handling where no horizontal pulling load is exerted on boom

Unit: metric ton

Working radius m	Boom length m (ft)	12.2 (40)	15.2 (50)	18.3 (60)	21.3 (70)	24.4 (80)
5.0		10.0				
6.0		10.0	10.0			
7.0		10.0	10.0	10.0		
8.0		10.0	10.0	10.0	10.0	
9.0		10.0	10.0	10.0	10.0	9.8
10.0		10.0	10.0	10.0	10.0	9.4
12.0		10.0	10.0	10.0	9.6	9.0
14.0			10.0	10.0	9.3	8.6
16.0				10.0	9.0	8.2
18.0					8.1	7.8
20.0					7.0	6.9
22.0						6.1

## Working Range

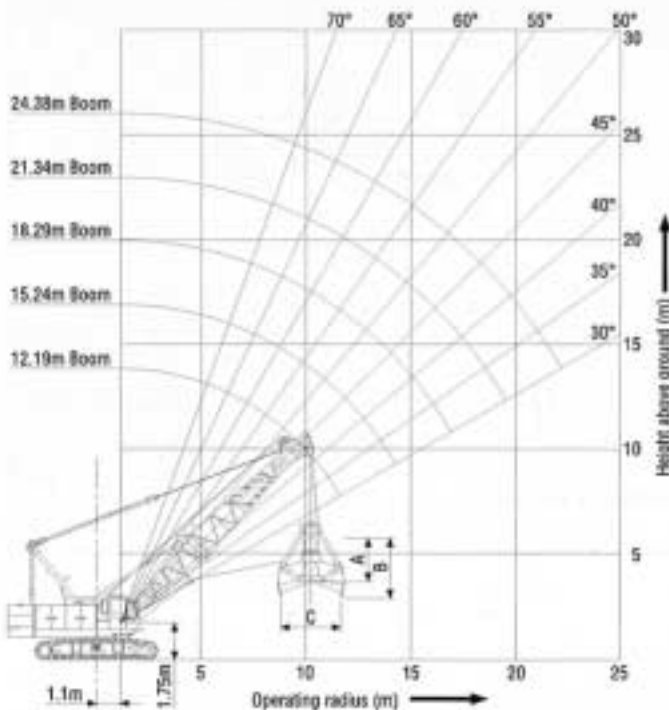

## Note:

- Working radius is the horizontal distance between the center of rotation and the bucket's center of gravity.
- Total weight of bucket and materials must not exceed rated load.  
**Example of calculation:**  
Bucket capacity x Specific gravity of materials + Bucket weight = Rated load. (2.0 m<sup>3</sup> x 1.8 + 3.8 ton = 7.4 ton)
- Rating are determined from stability and strength of boom. During swing, avoid sudden starts and stops that exert horizontal pulling load on boom. Particular caution is advised with long-length booms.
- Rated loads are determined by degree of stability. During simultaneous operations of boom and swing, rapid acceleration or deceleration must be avoided. Particular care is required with long boom lengths.

## Clamshell Bucket

Bucket capacity (m <sup>3</sup> )	Approximate weight (ton)	Bucket dimensions (m)			Application
		A	B	C	
1.6	3.2	3.3	3.6	3.0	Loading
2.0	3.8	3.5	3.9	3.1	Loading
1.25	3.6	2.9	3.7	3.0	Digging
1.6	4.6	3.2	4.0	3.2	Digging

# Applications

## Hammer Grab



Job requirement		
Bore pile (mm dia.)		1,200 to 2,000
Digging depth (m)		30 to 50
Bucket weight (ton)		5 to 8
Contents (ton)		1 to 2
Line pull (ton)		6 to 10
Wire rope (mm dia.)		26

Recommended specification	
BM700HD	
Boom length (m)	21.3
Bucket rated line pull (ton)	10
Max. line pull (ton)	20
Wire rope (mm dia.)	26
Power plant (PS)	250
Capacity of wire rope by drum layer	1st 42m 2nd 45m
Suitable layer	1st to 2nd

## Earth Drill



Job requirement		
Bore pile (mm dia.)		800 to 1,500
Digging depth (m)		40 to 60
Bucket weight (ton)		7 to 9
Contents (ton)		1 to 2
Line pull (ton)		8 to 11
Wire rope (mm dia.)		26 or 28

Recommended specification	
BM700HD	
Boom length (m)	27.4
Bucket rated line pull (ton)	10
Max. line pull (ton)	20
Wire rope (mm dia.)	26
Power plant (PS)	250
Capacity of wire rope by drum layer	1st 42m 2nd 45m
Suitable layer	1st to 2nd

## Mechanical Diaphragm Wall Bucket

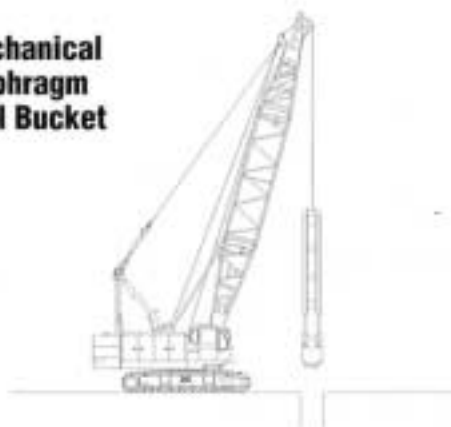

Job requirement		
Wall width (mm)		600 to 1,000
Digging depth (m)		30 to 60
Bucket weight (ton)		8 to 10
Contents (ton)		1 to 2
Line pull (ton)		9 to 12
Wire rope (mm dia.)		26 or 28

Recommended specification	
BM700HD	
Boom length (m)	15.2
Rated line pull (ton)	10
Max. line pull (ton)	20
Wire rope (mm dia.)	26
Power plant (PS)	250
Capacity of wire rope by drum layer	1st 42m 2nd 45m
Suitable layer	1st to 2nd

**Note:** Each applications are in general values. It may vary in certain conditions. If you need further information, please consult with our dealer or branch near you.

# General Dimensions

**BM700HD**

Unit: mm

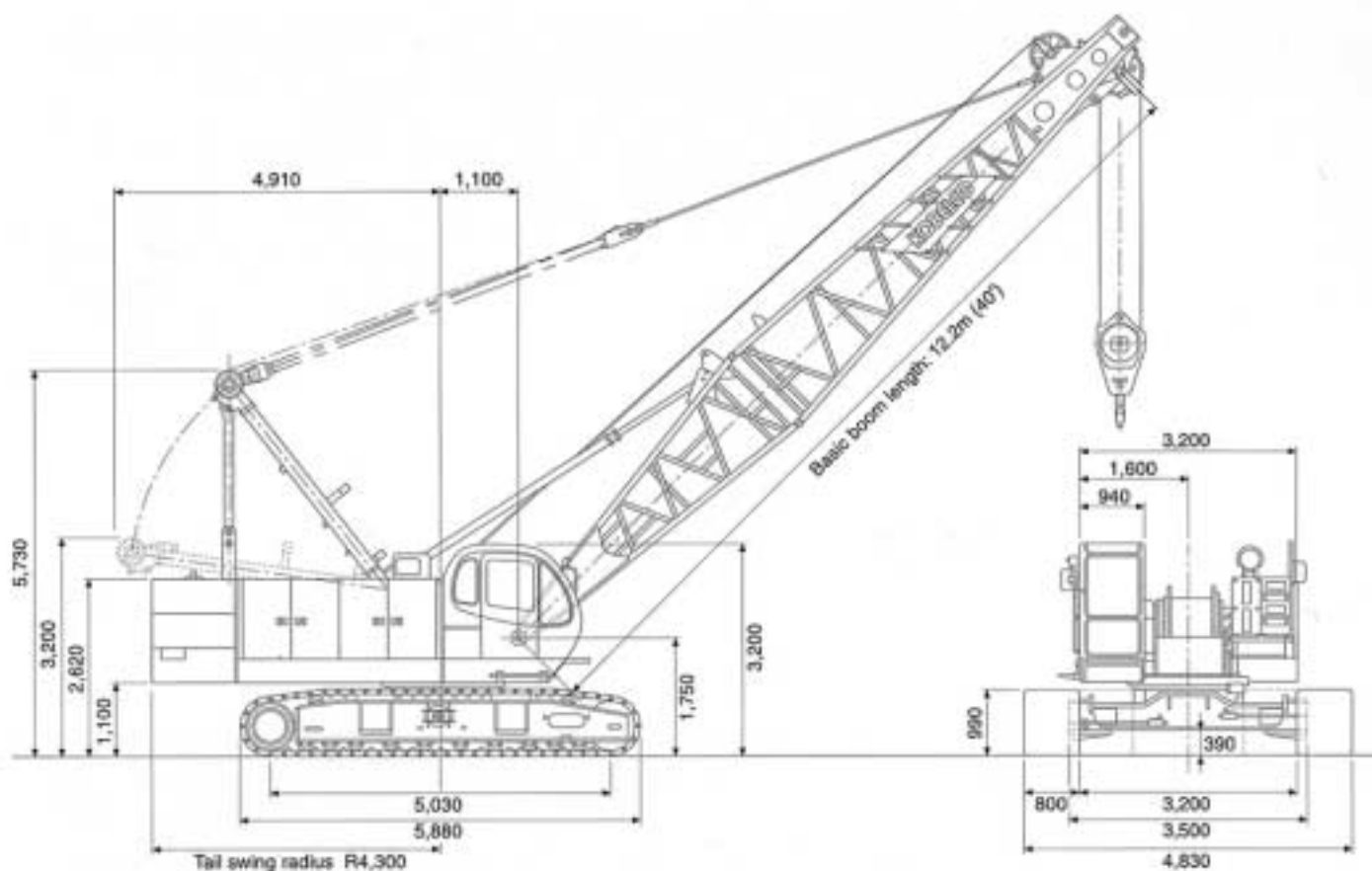

## Basic frame structure

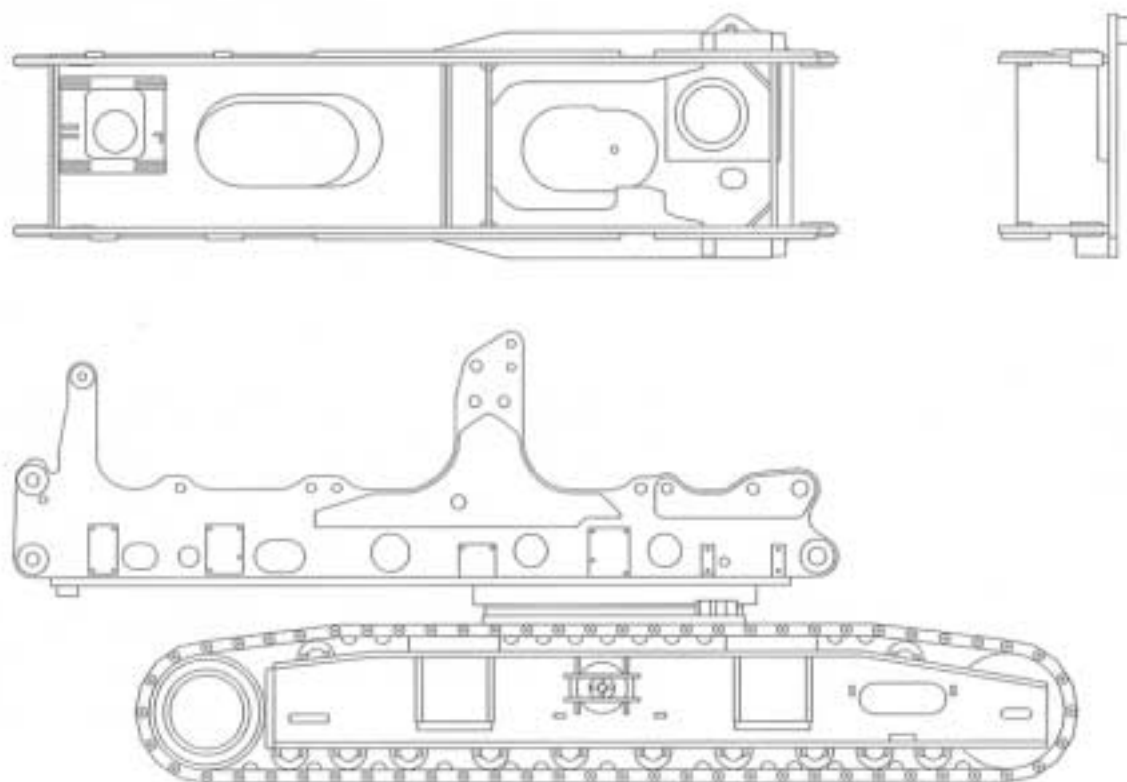

**Note:** Optional reinforced steel plates are included in above frame structure.

# KOBELCO

**HEAVY DUTY BASE MACHINE  
FOR FOUNDATION WORK**

***BM700HD***

Address inquiries to:

NOTE: Due to our policy of continual product improvement, all designs and specifications are subject to change without advance notice.

**KOBELCO CONSTRUCTION MACHINERY CO., LTD.**

17-1, Higashigotanda 2-chome, Shinagawa-ku, Tokyo, 141-8626 JAPAN  
Tel: ++81 (0) 3-5789-2124 / Fax: ++81 (0) 3-5789-2137