

CKE2500-2

KOBELCO

HYDRAULIC CRAWLER CRANE *CKE2500*

CRANE BOOM

Max. Lifting Capacity: 250 tons × 4.6 m

LUFFING BOOM

Max. Lifting Capacity: 150 tons × 7.0 m

LONG BOOM

Max. Lifting Capacity: 47.1 tons × 12.8 m

FIXED JIB

Max. Lifting Capacity: 27 tons × 10.4 m

LUFFING JIB

Max. Lifting Capacity: 80 tons × 9.8 m

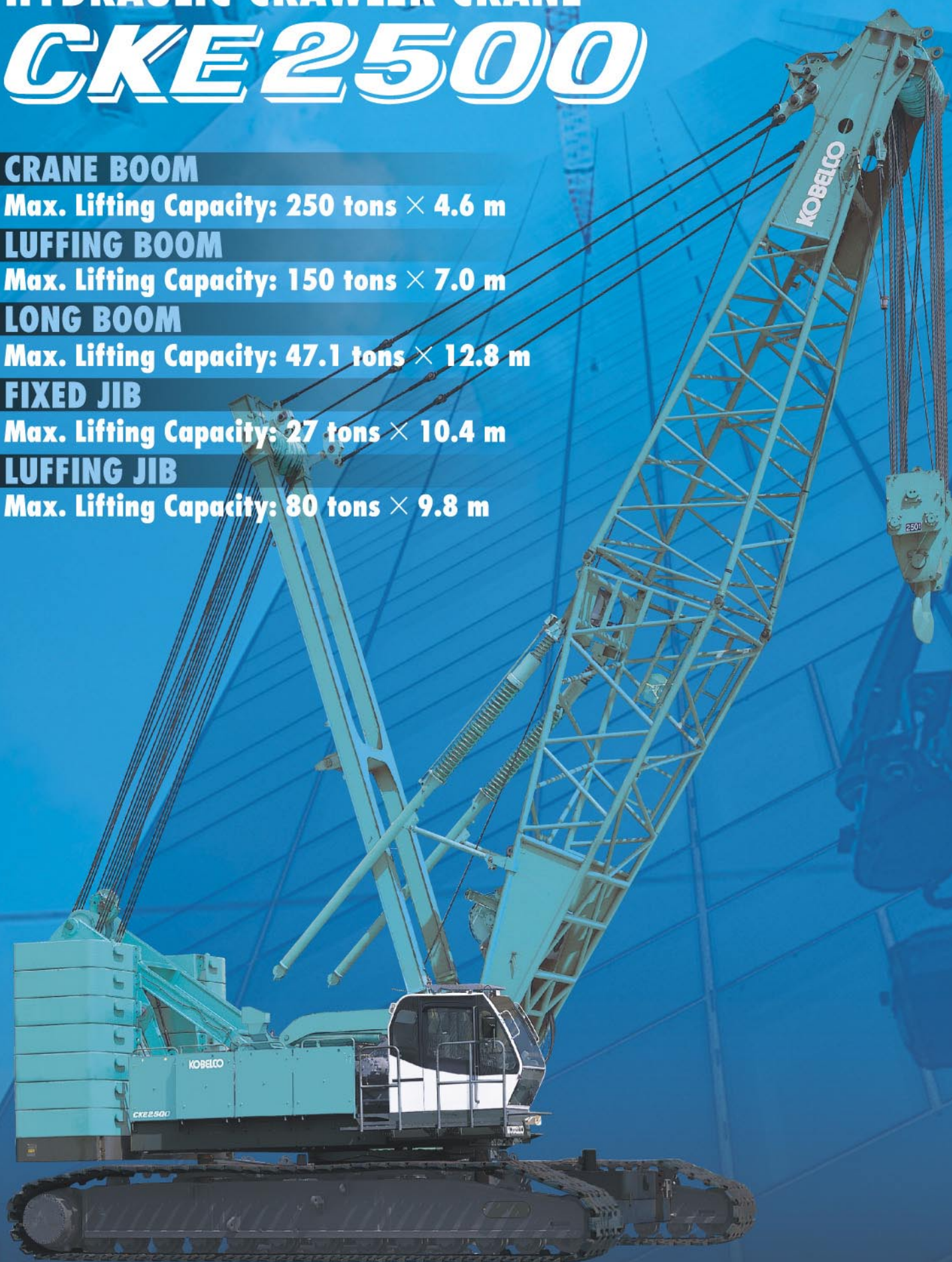

The CKE2500 crawler crane from KOBELCO uses new technologies to raise performance to new heights. New winches with greater line pull can handle the toughest jobs with ease. Large drum capacities ensure ultra-smooth operation and longer component service life. But our engineering didn't stop with the CKE2500's superior performance. We also designed this crane to comply with European transport regulations, and fitted it with a self-assembly system for quick and economical onsite set-up. Add these new features to KOBELCO's renowned power and reliability, and you have the ideal combination of heavy lift performance, economical operation and tough durability that make the CKE2500 the premier crane in its class.



Experience KOBELCO's Aweso
MORE HEIGHT AN



CKE2500 Five Major Features

1

Massive and Versatile Lifting Performance

2

Smooth Operation and Control

3

Excellent Cab with Enhanced Functions

4

Excellent Transportability and Assembly

5

Safe, Environmentally-Conscious Design

More Power, Speed and Efficiency!

D MORE POWER

For both high and heavy lifting

Massive and Versatile Lifting Pe

Meets Diverse User Needs

High-rise lifting is a delicate job that requires accuracy and speed, while heavy lifting requires stable power and tough durability. The CKE2500 can perform crane operations even using the luffing boom, enabling it to perform heavy lifting on the spot at high-rise worksites.

Crane Boom

Max. Lifting Capacity:

250 tons × 4.6 m

Luffing Boom

Max. Lifting Capacity:

150 tons × 7.0 m

Long Boom Configuration to Achieve Wider Working Ranges

The newly adopted long boom specification provides a wider operating range with plenty of lifting capacity. The long boom can be made up of insert boom and luffing insert jib, to make economic use of attachment components.

Long Boom

Long Boom Length:

64.0 m to 91.4 m

Lifting Capacity at
Max. Operating Radius:

4.4 tons × 80.7 m
(Using the long 91.4m boom)

Luffing Jib Configuration for Higher and Deeper Sites

The luffing jib specification makes it possible not only to reach higher and operate with greater range, but also to increase performance capacity within a larger working radius.

Luffing Jib

Max. Combination (Luffing Boom + Jib):

61.0 m + 61.0 m



High-Output Engine

The engine has an impressive rated output of 247 kW and complies with NRMM (Europe) Stage IIIA and US EPA Tier III exhaust emissions regulations. All of this power works with KOBELCO's unique Engine Speed Sensing (ESS) control system and new hydraulic systems to ensure stable and smooth simultaneous operations.

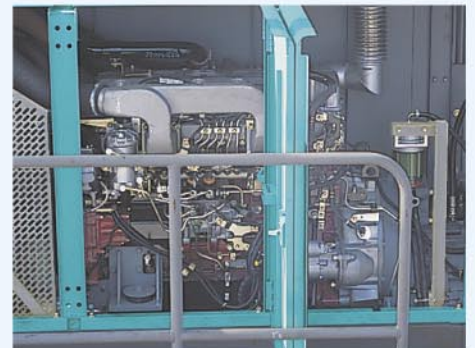

Engine Output:

247 kW

Meets NRMM (Europe) Stage IIIA

Performance

High-Performance Winch Accommodates a Wide Range of Jobs

Wide, Large-Capacity Winches for Smooth High-Rise Work

The wide hoist winches provide an impressive spooling capacity of 60 m on the first layer with a 25 mm hoist rope. Their large capacity and large diameter help to prevent uneven spooling and wear while ensuring smooth operation when using a long boom for high-rise work.

Spooling Capacity (First Layer):

60 m



Winches with a Powerful Line Pull Handle Hard Work with Ease

Through the efficient match-up of a high-output engine and high-performance hydraulic motors, the winches deliver plenty of line pull for single-line work. There's also ample capacity for heavy loads when they first clear the ground, and other tough jobs.

Rated Line Pull (Single Line):

132 kN {13.5 tf}

High-Speed Lifting Increases Work Efficiency

The main and auxiliary winches deliver a fast maximum hoisting and lowering speed of 110 m/min that improves operational efficiency on high-rise jobs.

Max. Line Speed (First Layer):

110 m / min



New Crawler Design Improves Performance

Large crawlers have been added to further improve stability, while keeping the tail swing radius to just 6,000 mm. The result is a machine with great lifting capacity that can operate in a minimum of onsite space.

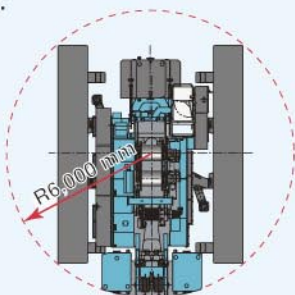

Choice of Two Types of Winch

The CKE2500 features a non free-fall winch as standard that provides constant hydraulic power to the winches to prevent accidental free-fall through operator error. An optional free-fall winch (with wet-type disc brake) is also available, which delivers highly reliable performance for material handling and general foundation work.

Non Free-fall Winch (Standard)

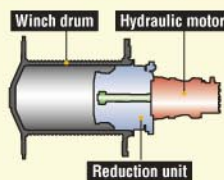

Wet-Type Disc Brake System (Optional)

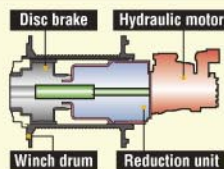

Maintenance-Free Winches

Both types of winches are maintenance-free. The built-in wet-type disc brake for the free-fall winch has a forced-oil cooling system to prevent overheating, and requires no band adjustment or lining replacement.

Environmentally Friendly Design

Because there's no brake band, the brake operates quietly and doesn't generate lining dust.

KOBELCO's new oil-cooled wet-type multi-disc brake system is first in its class and provides quiet, dependable braking power. The multiple discs are self-adjusting and self-equalizing. Forced-oil circulation keeps brake temperatures cooler during long, continuous operations and ensures smooth braking. The completely enclosed system eliminates the possibility of outside contamination, providing years of problem-free service life. In optional free-fall mode, the brake pedal is easily depressed to reduce operator fatigue.

For greater work efficiency

Smooth Operation and Control

New Hydraulic System Improves Simultaneous Operations

In a conventional series hydraulic circuit (a conflux hydraulic circuit), the luffing jib winch is driven by the same hydraulic pump that drives the main or auxiliary winches. This can result in hydraulic pressure interference that reduces line speed when the hook and jib are hoisted or lowered simultaneously. The CKE2500 features independent hydraulic circuits switching system for the main, auxiliary, and luffing jib winches, thereby eliminating interference. The circuits can be operated simultaneously with lower shocks and virtually no speed reductions, regardless of winch speed or load condition.



New hydraulic system

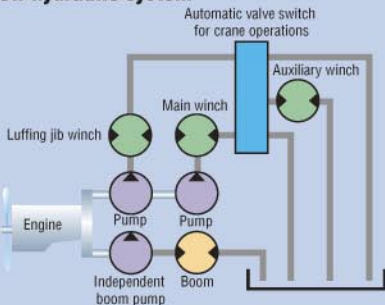

Control Levers Connected Directly to Pilot Valves for Smooth Operation

The control levers regulate the pilot valves directly to reduce the amount of play and ensure smooth, precise hoisting start-ups and inching. Control is light and sure, with almost no clatter even over long operating periods.



Selectable Swing Modes to Match the Job at Hand

■ Free Swing Mode (High/Low):

This mode is designed for material handling and other cycle-duty operations that require consecutive swing cycles. The swing is completely free and can be operated at High or Low speed to suit job requirements.

■ Neutral Brake Swing Mode:

When the crane is working on a slope in Free Swing Mode, it may swing in an unintended direction as soon as the swing parking brake is released. To prevent this, the Neutral Brake Swing Mode reduces operating speeds by lowering the flow of oil in the hydraulic circuit, thus making swing starts and stops easy to control when working on a slope or in windy conditions. Swing speed is also reduced in this mode to prevent the load from moving sideways.



Winch Speed Controller



The speeds of the main winch, auxiliary winch and boom hoist can be set independently with trimmer controls.



■ Hydraulic pilot system detects swing reaction force.

■ Electric throttle with a twist grip ensures sensitive engine control.



■ Red switch on the boom lever grip allows easy inching control for hoist, boom hoist, and travel. The operator can activate it without taking his hands off the boom hoist lever.

For better man-machine communication

Excellent Cab with Enhanced Functions

Multi-Function LMI Display

The newly designed load moment indicator (LMI) system features a large, easy-to-read LCD display. The rated load, actual load, load ratio, and other information are displayed in large characters. Warnings and other items are displayed in color, and text messages and alarms alert the operator to prevent dangerous conditions from developing. Other information can also be displayed, including a rated load chart and rated load curve, in addition to a function that regulates the working range.

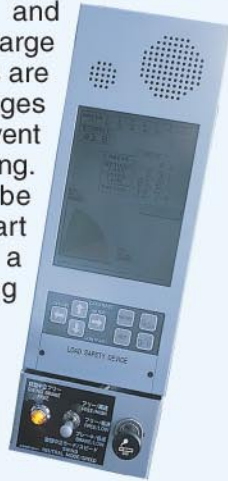

Multi Display

The easy-to-read LCD multi display provides information on the current status of such functions as engine rpm, maintenance, and on-board troubleshooting, so that the operator has an ongoing, real-time assessment of the machine's condition at a glance.

Normal Displays

- Engine speed (Lifting height*¹)
- Engine oil change interval
- Reeving number for main/aux winch wire rope
- Low-speed switch status
- Wind speed*²

*¹With the optional lifting height gauge installed

*²With optional anemometer installed

Warning Displays

- Warning (malfunction, maintenance information, etc.)
- Self-diagnostic function (detects malfunctions in solenoid valves, sensors, etc.)



Clear, Panoramic View

The CKE2500 has a new cabin design with sash-less front and top glass that provides a panoramic frontward and skylight view. The glass also has less curvature to minimize distortion. The front upper window has been broadened on both sides for a view that is 31% wider than a conventional cab, while the top-window view is widened toward the rear.

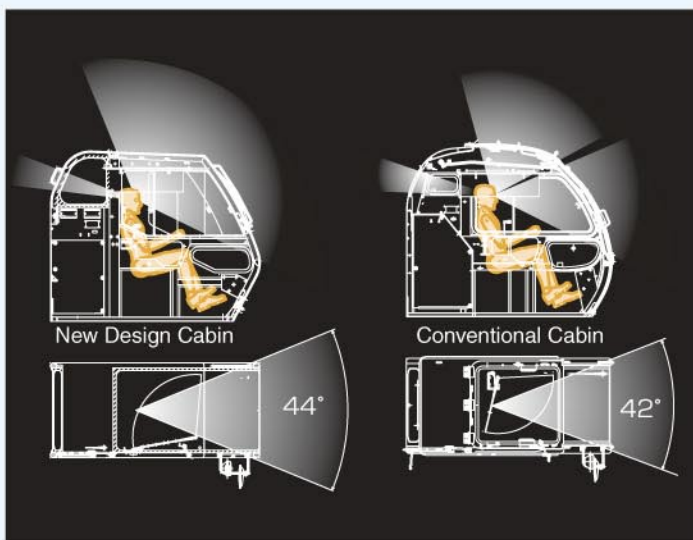

Comfortable 940mm-Wide Cab

- Air conditioner
- Fully adjustable, high backed seat with a headrest and armrests
- Intermittent wipers and window washers
- Sun visor
- Roof blind



■ Luggage tray



■ Cup holder



To ensure safe assembly and increase actual working hours

Excellent Transportability and Assembly

Base Machine Width of 3.4 m Designed for Easier Transport

With a base machine width of just 3.4 m, the CKE2500 is designed for easy transport. Total transportation weight (including mast, gantry and carbody) is 44.9 tons, complying with transport regulations in Europe and helping to reduce the number of trailers required.

Transport width: 3.4 m Transport weight: 44.9 tons

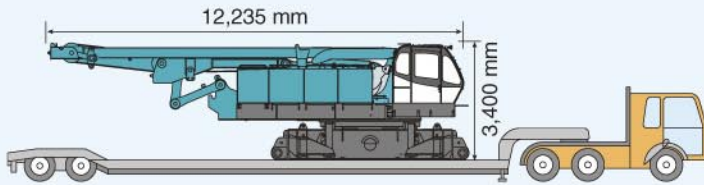

Boom Assembly/Disassembly Mode

The boom assembly/disassembly mode, which is used to release the over-hoist prevention function to facilitate boom assembly and disassembly, is activated with a switch located under the multi-function LCD display of the load moment indicator (LMI). (This switch is different from the switch that releases the auto-stop functions for over-load and hook over-hoist.) When the boom is lifted to a certain angle, it is automatically deactivated and the LMI function is automatically re-engaged to ensure that the boom assembly/disassembly function is used only when needed.



Self-Erection System

Use the built-in, remote controlled trans-lifter (jack system) to lift the CKE2500 clear of the trailer, then drive the trailer away. Hydraulic cylinders raise the gantry and the mast to their working position. The mast is reeved with a hook block and is used to lift and attach the front and rear carbody counterweights, the crawler side frame, and the boom. The rear counterweight assembly is raised into position by the gantry.

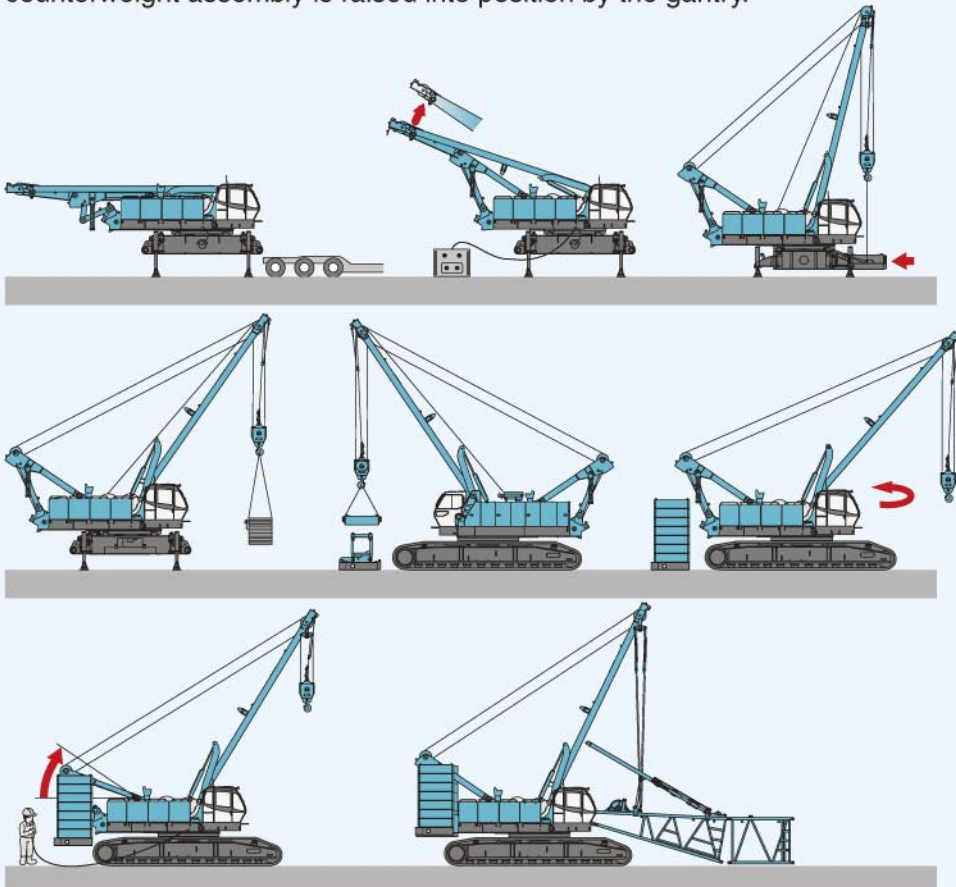

Saving Storage and Transport Costs through the Common Use of Boom and Jib

The CKE2500 features an innovative boom design to enhance lifting performance. The common use of the boom and jib reduces labor when changing configurations and saves storage and transport costs.

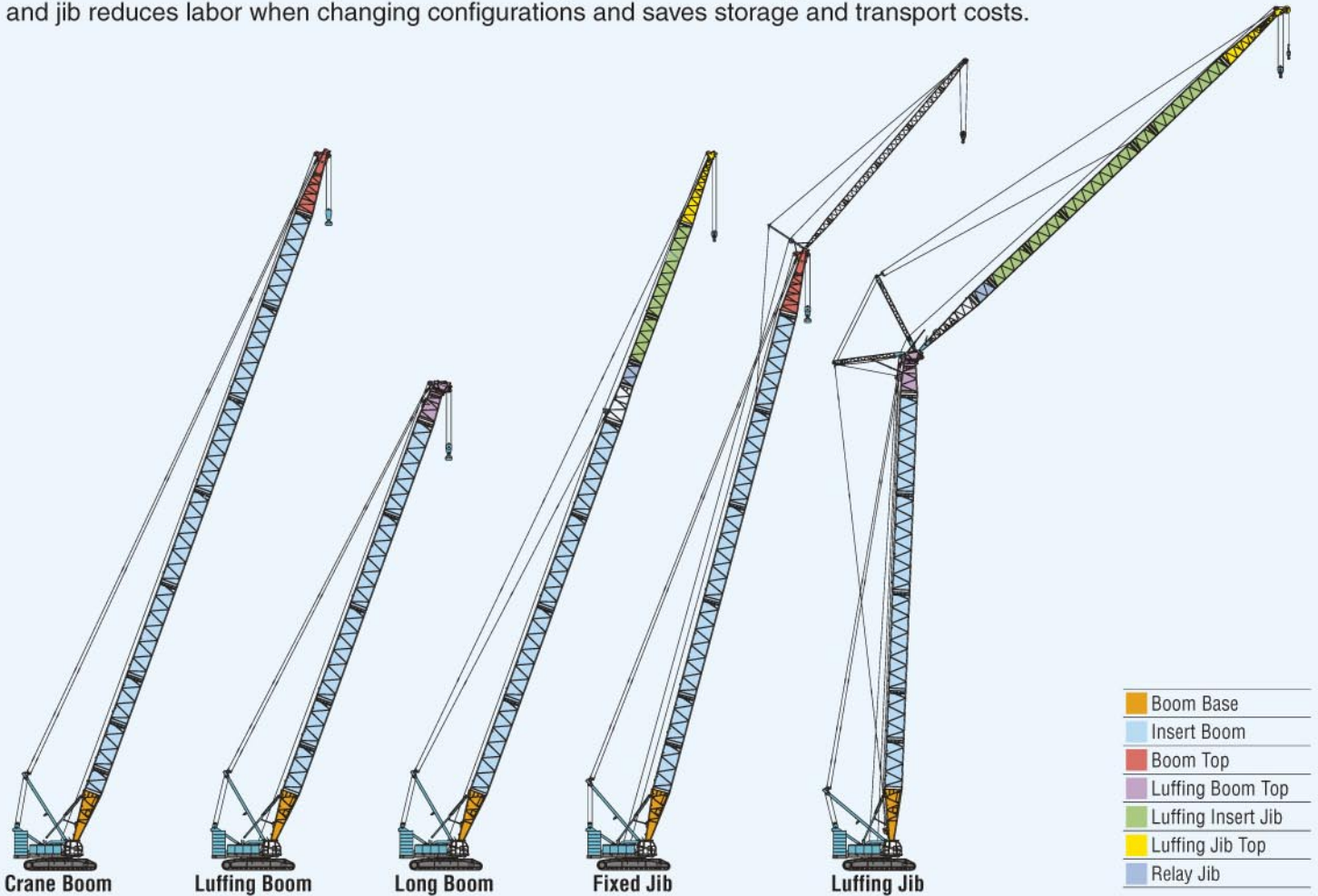

Faster Attachment Transport and Assembly

A variety of new mechanisms greatly reduce the time needed to assemble attachments. This results in lower labor and assist-crane costs, and greater productivity on the job.

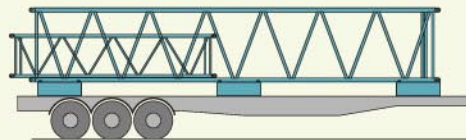

Attachment Transport Streamlined in Four Big Ways

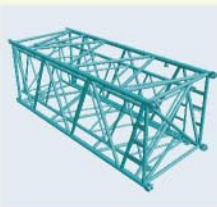

1 Nested Booms Improve Transport Efficiency

The luffing insert jib can be easily nested in the insert boom by using the optional stowing guide rollers. This reduces the number of trailers needed for transport and helps to minimize required storage space.



3 Symmetrical, Thin Counterweights

Symmetrical, thin counterweights ensure a low transport height when loaded on a trailer with the boom. Also, the counterweights can be assembled in any order, making transport planning easier.



2 Boom Connector Pin Holder

The boom connector pin holder prevents the loss of boom connector pins during assembly/disassembly and transportation.

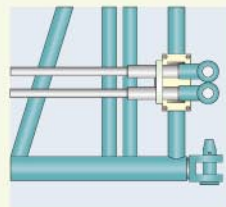

4 Guy Cable Stowing Bracket (Optional)

The stowing bracket makes securely tighten the guy cables on the boom inserts for transportation. This also ensures that the guy cables are correctly installed during assembly.



No compromise in KOBELCO's safety policy

Safe, Environmentally-Conscious

Two-Stage System to Prevent Boom and Jib Over-Hoists

With primary and secondary over-hoist prevention devices, this new safety system can prevent boom over-hoist at two stages. The primary stop function is activated when the boom or luffing boom approaches the critical angle-to-ground during hoisting. This new system monitors the angle-to-ground of the boom, luffing boom or jib with a sensor, and swiftly alerts the operator of danger. For the

luffing boom, the angle-to-machine is also monitored at this stage. The secondary stop function uses a device that monitors the angle-to-machine of the boom, luffing boom, or jib through a limit switch fitted to the boom and jib backstops. It stops the machine automatically to prevent it from working outside of the safety range, and once activated it cannot be cancelled.

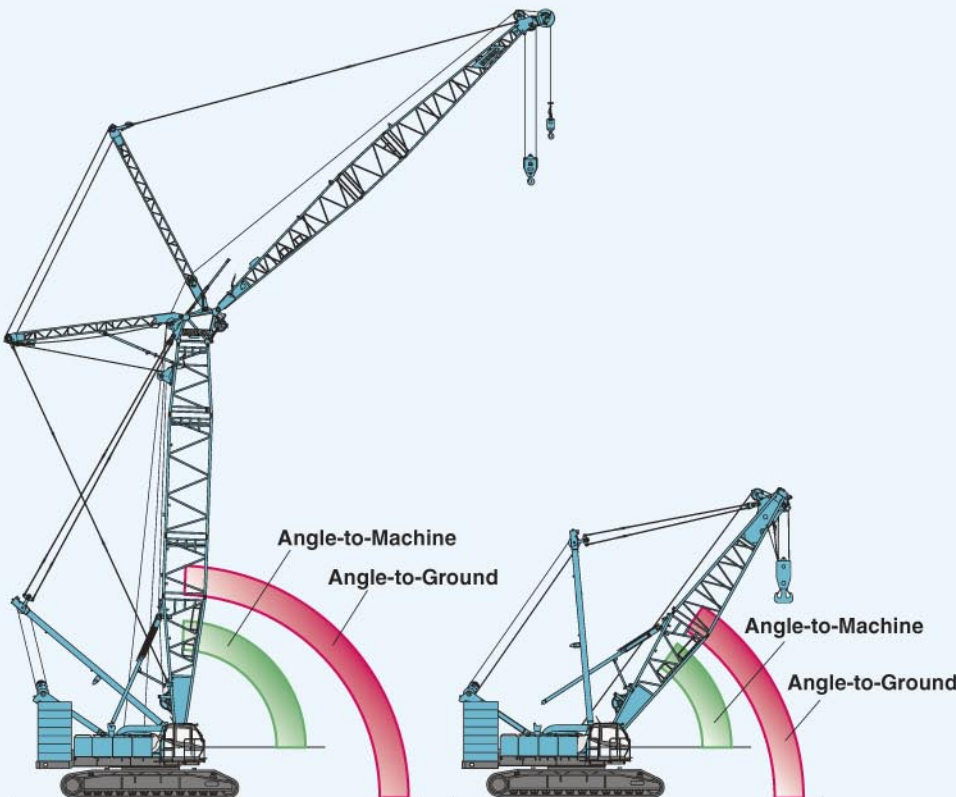

Automatic Soft-Stop Function Reduces Shocks

This function is activated automatically when boom or luffing jib lowering, or boom hoisting is stopped by the over-hoist prevention system. It makes for a smooth stop and prevents the load from swinging sideways.

Automatic Stop Release Switch with Safety Function

The automatic stop system prevents over-load, hook over-hoist and boom over-hoist. To deactivate the system, a two-stage release procedure is employed that uses a master key and separate switches. This makes it easy to supervise the use of the single key and prevent unauthorized release of the automatic stop system.



Safety Functions of the Optional Free-fall Winch

Free-fall with Monitoring and Lock Functions

Free-fall operations can only be initiated by releasing the lock using a key switch. Unless the lock is released, free-fall cannot occur even if the switch is put in the "neutral-free" position. Also, to prevent the free-fall mode from being activated accidentally because of system malfunction, a monitoring function monitors the free-fall clutch cylinder pressure in the winch.

Free-fall Switch with Interlock

The free-fall switches are strategically located on the hoist levers, allowing the operator to engage free-fall without removing his hands from the control levers. To prevent the load from accidentally dropping, the interlock



function makes it impossible to initiate free-fall unless the foot brake is fully depressed.

⚠ To prevent the load from accidentally dropping because of operator error, do not use free-fall when lifting.

Other Safety Features



Function lock lever helps prevent accidental operation when the operator enters or leaves the cab.



Directional markings on the crawlers make it easy to see which direction the crawlers will move.



One-way call supports the safety of onsite personnel (optional).

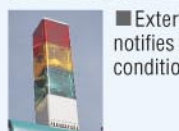

External lamp for over-load alarm notifies surrounding workers of the load condition.

Swing flashers and warning buzzer warn surrounding workers when the machine is swinging.
Cameras and color monitor provide views of the rear of the machine, the main and auxiliary winches, and the boom hoist winch (optional).

Design

Side-Engine Layout for Easy Maintenance

A new engine layout on the side of the machine provides easy access for routine inspections and servicing. Maintenance crews can access the entire power plant just by opening the side door.

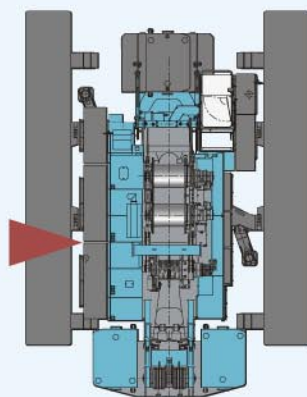

Super-Fine Filter, a Long-Life Filter for Hydraulic Oil

The large-capacity, super-fine filter is made of a high-performance filter medium consisting of glass fiber reinforced with steel wires. The replacement cycle is extended to four times longer than that of conventional filters to reduce lifelong operating costs.

Photomicrograph ($\times 250$)

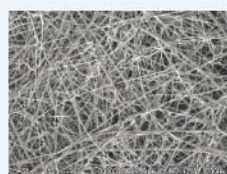

Super fine filter
(glass fiber)



Conventional filter
(paper fiber)



Conforms with European Exhaust-Gas and Noise Regulations

The CKE2500 meets NRMM Stage IIIA exhaust emissions regulations in Europe, and is designed with advanced KOBELCO low-noise construction technologies to comply with European Noise Regulations.



■ Main Specifications (Model: CKE2500-2)

Crane Boom	
Max. Lifting Capacity	250 t/4.6 m
Max. Length	91.4 m
Luffing Boom	
Max. Lifting Capacity	150 t/7.0 m
Max. Length	61.0 m
Long Boom	
Max. Lifting Capacity	47.1 t/12.8 m
Max. Length	91.4 m
Fixed Jib	
Max. Lifting Capacity	27 t/10.4 m
Max. Length	30.5 m
Max. Combination	76.2 m + 30.5 m
Luffing Jib	
Max. Lifting Capacity	80 t/9.8 m
Jib Length	21.3 m ~ 61.0 m
Max. Combination	61.0 m + 61.0 m
Luffing Angle	63°~88°
Main. & Aux. Winch	
Max. Line Speed	110 m/min (1st layer)
Rated Line Pull (Single line)	132 kN {13.5 tf}
Wire Rope Diameter	25 mm
Wire Rope Length	480 m (Main), 390 m (Aux.)
Brake Type	Spring set hydraulically released (Negative)
Free-Fall Brake Type	Wet-type multiple disc brake (Optional)

Working Speed	
Swing Speed	2.2 min ⁻¹ {rpm}
Travel Speed	1.1/0.7 km/h
Power Plant	
Model	Hino P11C-UN
Engine Output	247 kW/2,000 min ⁻¹ {rpm}
Fuel Tank Capacity	400 liters
Hydraulic System	
Main Pumps	4 variable displacement
Max. Pressure	31.9 MPa {325 kgf/cm ² }
Hydraulic Tank Capacity	600 liters
Self-Erection Device	
	Standard
Weight	
Operating Weight*	Approx. 213 t
Ground Pressure*	108.4 kPa {1.11 kgf/cm ² }
Counterweight	90.0 t (Upper), 24.0 t (Lower)
Transport Weight**	Approx. 44.9 t

Units are SI units. { } indicates conventional units.

Line speeds in table are for light loads. Line speed varies with load.

* Including upper and lower machine, 90.0 ton counterweight and 24.0 ton carbody weight, basic boom, hook, and other accessories.

**Base machine with trans-lifter, main and aux. winches (non-free fall) including wire rope, and boom hoist winch including wire rope.

■ General Dimensions (Unit: mm)

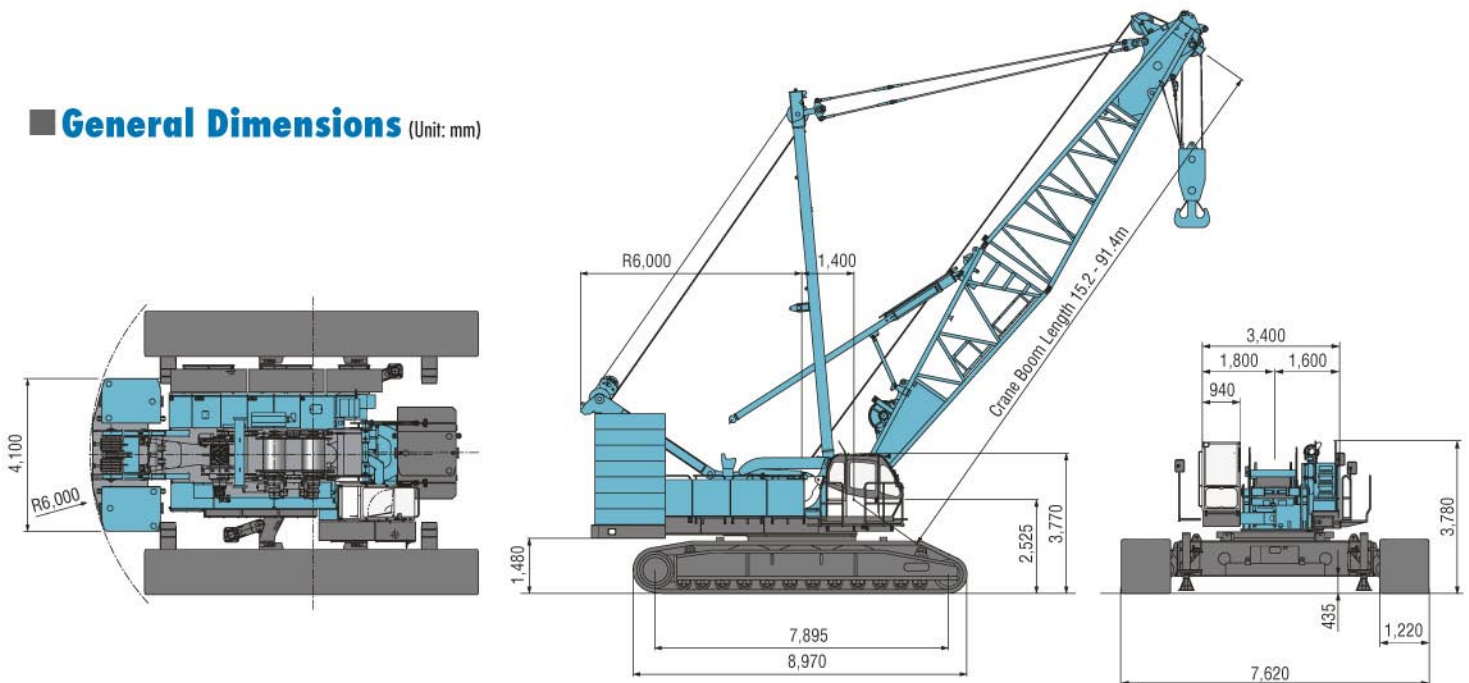

Note: This catalog may contain photographs of machines with specifications, attachments and optional equipment not certified for operation in your country. Please consult KOBELCO for those items you may require. Due to our policy of continual product improvements all designs and specifications are subject to change without advance notice.

Copyright by KOBELCO CRANES CO., LTD. No part of this catalog may be reproduced in any manner without notice.



KOBELCO CRANES CO., LTD.

17-1, Higashigotanda 2-chome, Shinagawa-ku, Tokyo 141-8626 JAPAN
Tel: +81-3-5789-2130 Fax: +81-3-5789-3372

Inquiries To:

KOBELCO is the corporate mark used by Kobe Steel on a variety of products and in the names of a number of Kobe Steel Group companies.

Bulletin No. CKE2500-2-EU2

070301IF Printed in Japan